

Facsimile

Quick Reference Guide

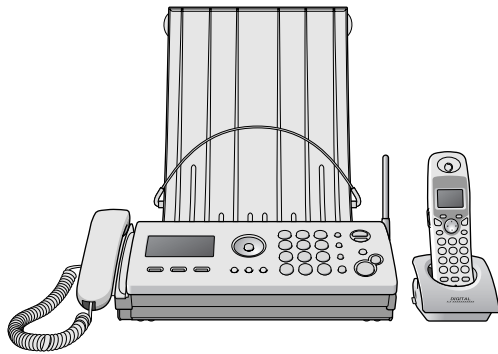

KX-PW503DL

Model No. **KX-PW503DL**
KX-PW503DW

Main unit: KX-PW503
Portable handset: KX-FKN521

Thank you for purchasing a Panasonic facsimile.

Table of Contents

Finding the controls	2
Installations and connections	4
Setting the date and time.....	7
Setting your facsimile telephone number	7
Setting your logo	8
Character input and command key table	9
Automatic dialing on the main unit	10
Automatic dialing on the portable handset (KX-FKN521)	12
Intercom	13
Sending faxes	14
Receiving faxes	15
Operating the built-in answering device	16
Specifications	18

- This guide explains some basic features and operations, but not all of them. For further details, see the Japanese operating instructions.
- This product is designed for use in Japan. Panasonic cannot provide service for this product if used outside Japan.
- Any details given in this guide are subject to change without notice.

Finding the controls

Main unit

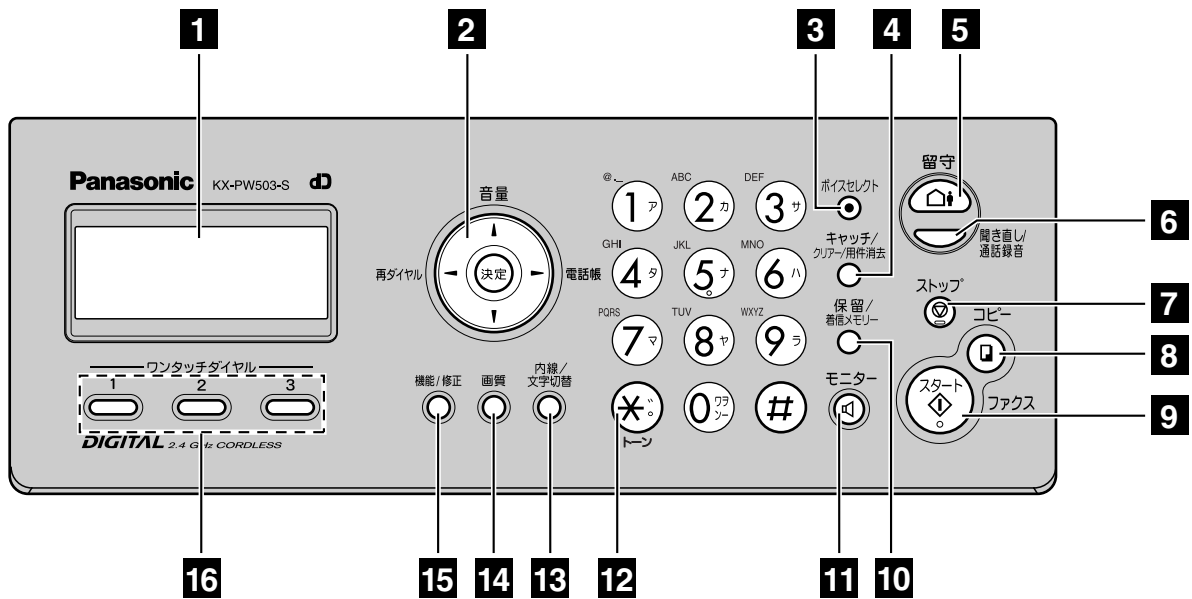

1 Liquid crystal display

2 Volume/Redial/Phonebook/Set key



To adjust the volume.



To redial the phone numbers in the redial list. The last 10 phone numbers dialed are stored in memory.



To use the phonebook.



To store a parameter.

3 Voice Select button changes the tone heard from the earpiece.

4 Flash button (For call waiting service users.) Clear/Erase button

5 Auto Answer button & indicator —light on: answering device activated. —light off: used as a regular telephone.

6 Replay button plays back recorded messages.

Record button records telephone calls.

7 Stop button

8 Copy button starts copying.

9 Start/Fax button starts faxing.

10 Hold button

Call Memory button starts a search in the Number Display log.
(For caller ID display service users.)

11 Monitor button

12 Tone button switches to tone dialing.

13 Intercom button

Character Input Mode button

14 Resolution button selects the resolution when faxing or copying.



15 Function button initiates programming. Edit button

16 One-touch Dial buttons





Finding the controls

Portable handset (KX-FKN521)

How to use  **key**

-  ● To use the phonebook.
-  ● To redial the phone numbers in the redial list. The last 10 phone numbers dialed are stored in memory.
-  ● To adjust the volume.

-  ● To change the tone heard from the earpiece.

-  ● To make/answer calls.
-  ● To end a call.
- To end or exit from editing or other operations.
-  ● To page the main unit and/or portable handset(s).
- To change the character input mode.
-  ● To put a call on hold.
- To start a search in the Number Display log. (For caller ID display service users.)

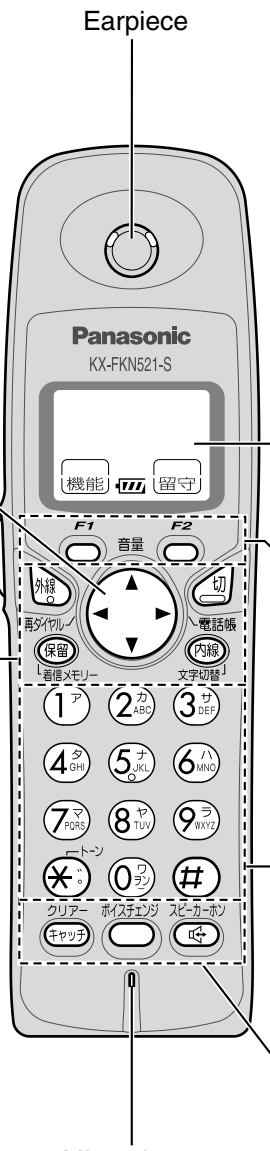



Liquid crystal display



- ① Portable handset number (and name)
- ② No link to the base unit
- ③ Function menu that is controlled by **F1** or **F2**
- ④ Battery strength

How to use **F1 **F2** buttons**

F1 and **F2** buttons refer to the function displayed on the bottom of the display. They function differently depending on the mode.

Dial buttons

-  **Tone button**
 - To switch to tone dialing.
-  **Sharp button**

-  ● For call waiting service users.
- To clear letters/numbers.
-  ● To change your voice.
- To mute your voice to the other party by pressing this button for about 2 seconds. (To release the mute, press this button again.)
-  ● To use the speakerphone.

Installations and connections

Installing the ink film

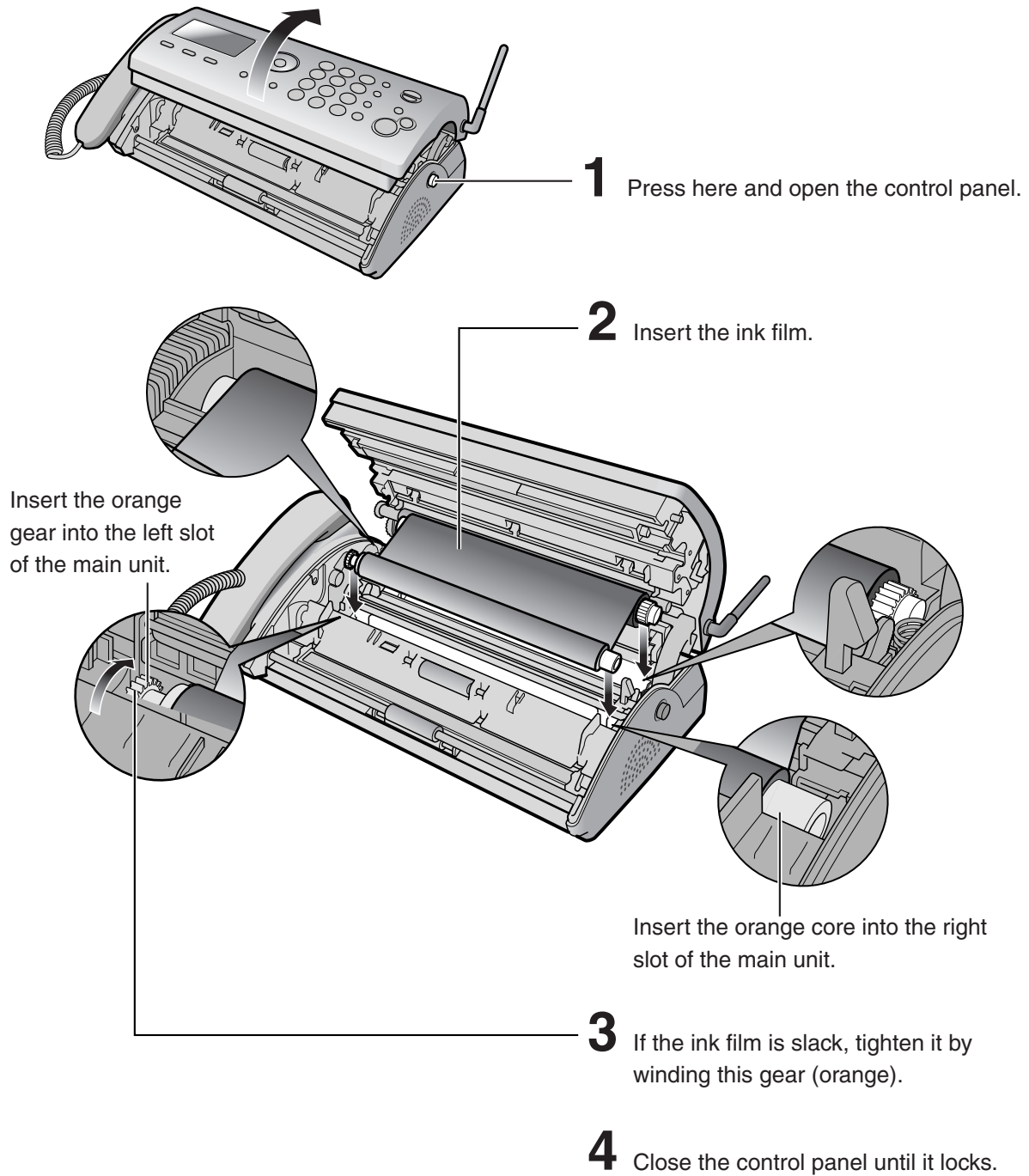

- When the unit runs out of ink film, the following message will be displayed.

フィルムカ ナクナリマシタ コウカンシテクタサイ U23	↔	フィルムカ ナクナリマシタ ヒンバツ : KX-FAN200
---------------------------------	---	-----------------------------------

Install a new ink film.

Replacement ink film: KX-FAN200 (30 m) ¥1,208
--

· As of September 2004. · Tax included.

Installations and connections

Installing recording paper (A4 size)

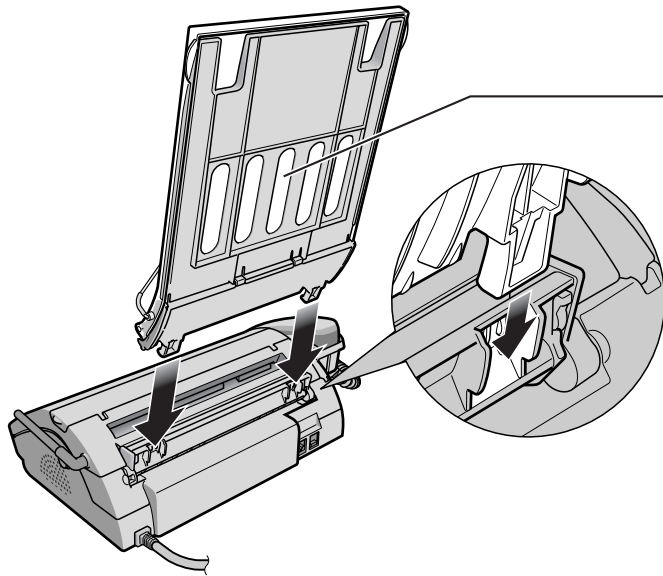

1 Install the recording paper cover/tray.

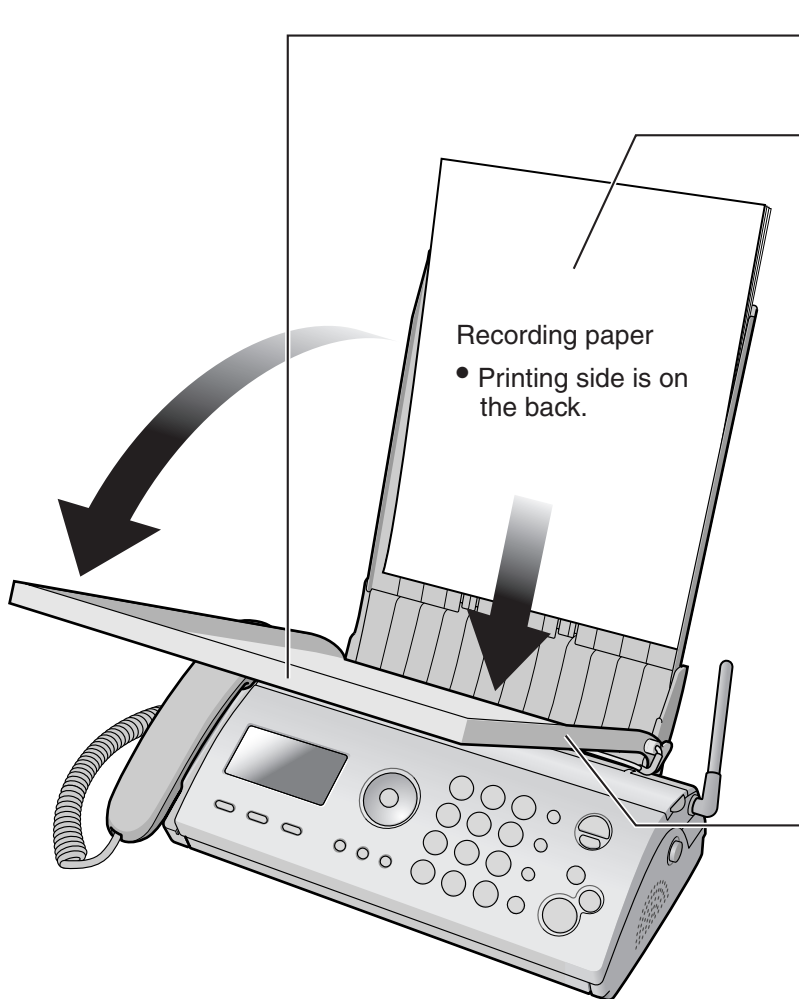

2 Open the recording paper cover.

3 Insert the recording paper into the recording paper tray. (Up to 20 sheets)

- Fan the stack of recording paper.

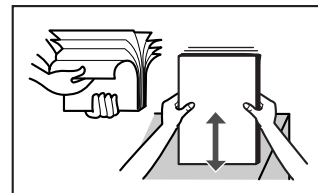

4 Close the recording paper cover.

Installations and connections

Connecting the main unit

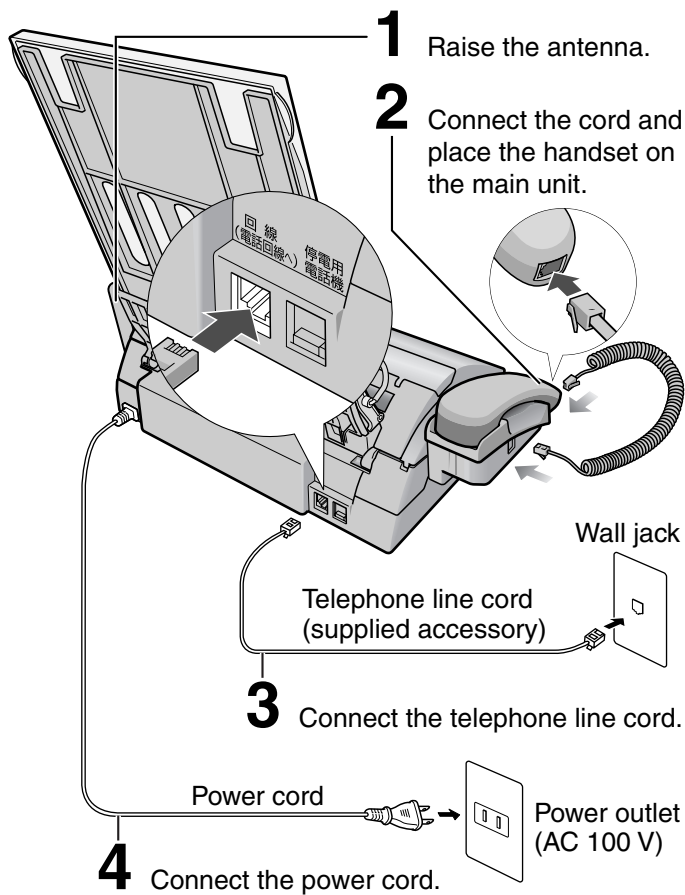

After the Power On...

This unit will automatically select the dialing mode (Tone/Pulse).

↓ If you can not make a call...

Set the dialing mode with the main unit.

1. Press (Function/Edit).
2. Press .
3. Press (Search button) repeatedly until the desired setting is displayed.

Example :

カイセツシユハツ=20 [◀▶,ケツテイ]オス	●フツシユ: Tone 20 : Pulse (20 pps) 10 : Pulse (10 pps)
----------------------------	---

4. Press (Set).
5. Press (Stop).

Setting up the portable handset (KX-FKN521)

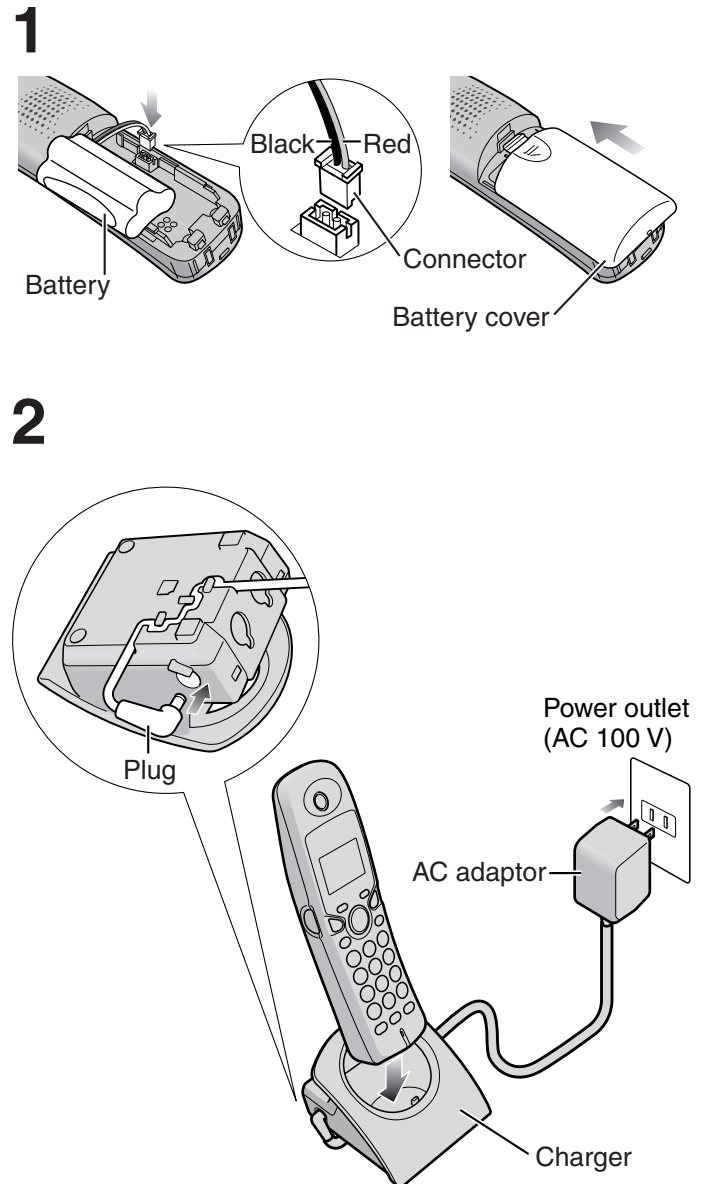

3 Charge the battery in the charger for 10 hours.

- After your Panasonic battery is fully charged, it will last up to about 7 hours of conversation.

Setting the date and time

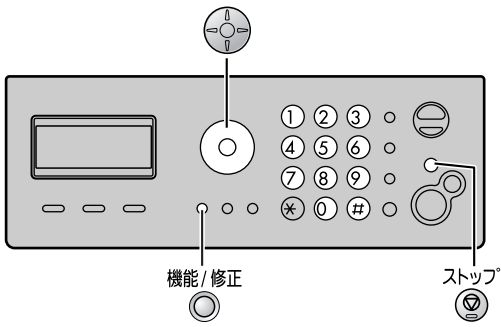

1 Press (Function/Edit).

キノウ トウロク モード
[▼▲]オス

2 Press .

Example : 2004年06月01日
20:10
Cursor

3 Enter the correct year/month/day.

Example: October 1, 2004

Press .

2004年10月01日
20:10

4 Enter the correct hour/minute in a 24-hour clock entry.

Example: 15:45 (3:45 PM)

Press .

2004年10月01日
15:45

5 Press (Set).

トウロク シマシタ



2004年10月01日
15:45

6 Press (Stop).

Example : 10月 1日 15:45
ヨウゲン ロクオン 00ケン

Setting your facsimile telephone number

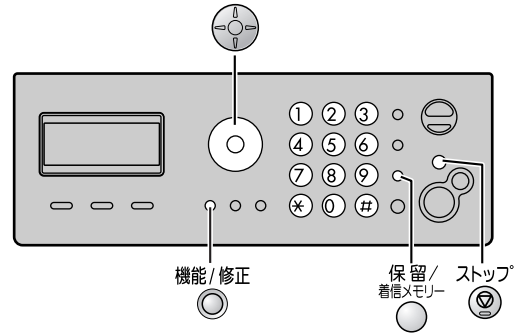

1 Press (Function/Edit).

キノウ トウロク モード
[▼▲]オス

2 Press .

アナタノデノワホンゴウ?
TEL=.....
Cursor

3 Enter your facsimile telephone number, up to 20 digits.

Example: 098 765 43..

アナタノデノワホンゴウ?
TEL=098,765,43..

The (Hold/Call memory) button replaces the digit with a space.

4 Press (Set).

トウロク シマシタ



アナタノデノワホンゴウ?
TEL=098 765 43.

5 Press (Stop).

Example : 10月 1日 15:45
ヨウゲン ロクオン 00ケン

Setting your logo

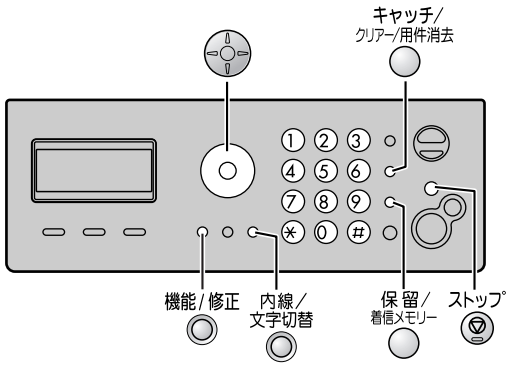

1 Press (Function/Edit).

キノ トウロク モード
[▼▲]オス

2 Press .

アナタノナマイ?
Cursor

3 Enter your logo, up to 30 characters, using the dial keypad.

- To enter English characters easily, press (Intercom/Character input mode) repeatedly and select “英” (English and sign input mode).
- For details, see the table on page 9 for instructions.

Example: Micah

1. Press once.

アナタノナマイ?
M
Cursor

2. Press six times.

アナタノナマイ?
Mi

3. Press six times.

アナタノナマイ?
Mic

4. Press to move the cursor to the next space and press four times.

アナタノナマイ?
Mica

5. Press five times.

アナタノナマイ?
Micah

4 Press (Set).

トウロク シマシタ
↓
アナタノナマイ?
Micah

5 Press (Stop).

Example : 10月 1日 15:45
ヨウケン ロクオン 00ケン

Automatic dialing on the main unit

Storing telephone numbers in the one-touch dial

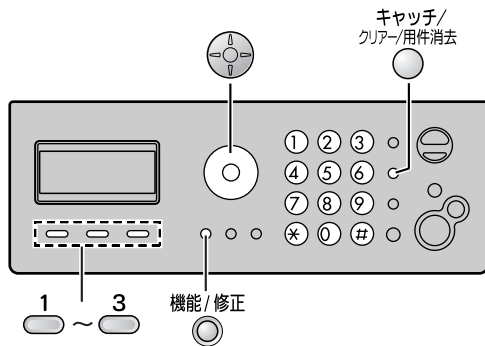

1 Press (Function/Edit).

キノウ トウロク モード
[▼▲]オス

2 Press the desired one-touch dial button (1 to 3).

Example: One-touch dial 1

ワンタッチ 1
トウロク サレテ イマセン

Button number

3 Enter the telephone number, up to 24 digits.

• To correct a mistake, press (Flash/Clear/Erase).

0987654

4 Press (Set).

Making a voice call using the one-touch dial

1 Press the desired one-touch dial button (1 to 3).

• The unit will start dialing.

2 When the other party answers, lift the handset.

Editing a stored number in the one-touch dial

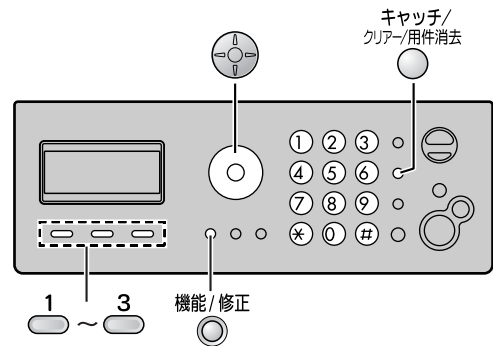

1 Press (Function/Edit).

2 Press the desired one-touch dial button (1 to 3).

3 Move the cursor to the number you want to edit.

4 Press (Flash/Clear/Erase).

5 Enter the number.

6 Press (Set).

Erasing a stored number in the one-touch dial

1 Press (Function/Edit).

2 Press the desired one-touch dial button (1 to 3).

3 Press and hold (Flash/Clear/Erase) until the telephone number has been erased.

4 Press (Set).

Automatic dialing on the main unit

Storing names and telephone numbers in the phonebook

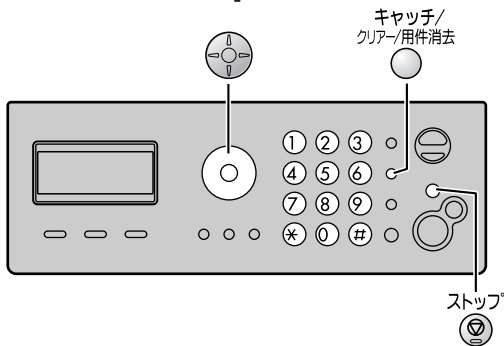

1 Press 電話帳 (Phonebook).

トウロク ハ [ケツタイ]オス
ケンサク ハ [▼▲]オス

2 Press 決定 (Set).

- “XXX” shows the remaining station numbers you can store.
- You can program up to 150 stations, including 4 pre-programmed stations.

テ ンワチヨウ アキXXXケン

3 Enter the name, up to 12 characters (see the table on page 9 for instructions).

4 Press 決定 (Set).

5 Enter the telephone number, up to 24 digits.

- To correct a mistake, press (Flash/Clear/Erase).

6 Press 決定 (Set).

7 Enter the group number (① to ⑨).

8 Press 決定 (Set).

- To program other items, repeat steps 3 to 8.

9 Press ストップ (Stop) to exit the program.

Making a voice call using the phonebook

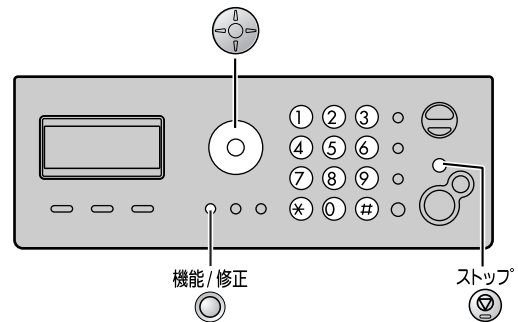

1 Press 電話帳 (Phonebook).

2 Press (Search button) repeatedly until the desired name is displayed.

3 Lift the handset.

Editing a stored name or number in the phonebook

1 Press 電話帳 (Phonebook).

2 Press (Search button) repeatedly until the desired name is displayed.

3 Press 機能/修正 (Function/Edit).

4 Edit the name (see the table on page 9 for instructions).

- If you do not need to edit the name, skip to step 5.

5 Press 決定 (Set).

6 Edit the telephone number.

- If you do not need to edit the telephone number, skip to step 7.

7 Press 決定 (Set).

8 Edit the group number.

- If you do not need to edit the group number, skip to step 9.

9 Press 決定 (Set).

10 Press ストップ (Stop).

Automatic dialing on the portable handset (KX-FKN521)

Storing names and telephone numbers in the phonebook

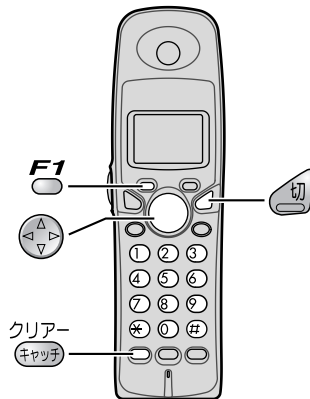

1 Press 電話帳 (Phonebook).

ケンサクハ [▼▲]オス

2 Press .

- “XXX” shows the remaining station numbers you can store.
- You can program up to 150 stations, including 4 pre-programmed stations.

ナマイ? [カナ]
アキ XXXケン

3 Enter the name, up to 12 characters (see the table on page 9 for instructions).

4 Press .

5 Enter the telephone number, up to 24 digits.

- To correct a mistake, press (Clear).

6 Press .

7 Enter the group number (① to ⑨).

8 Press .

- To program other items, repeat steps 3 to 8.

9 Press (Off) to exit the program.

Making a voice call using the phonebook

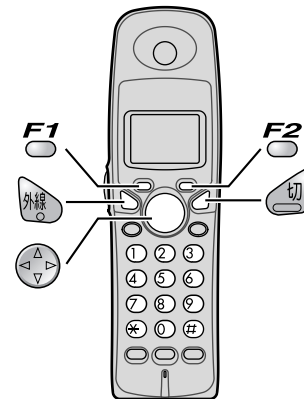

1 Press 電話帳 (Phonebook).

2 Press (Search button) repeatedly until the desired name is displayed.

3 Press (Talk).

Editing a stored name or number in the phonebook

1 Press 電話帳 (Phonebook).

2 Press (Search button) repeatedly until the desired name is displayed.

3 Press .

4 Edit the name (see the table on page 9 for instructions).

- If you do not need to edit the name, skip to step 5.

5 Press .

6 Enter the correct telephone number.

- If you do not need to edit the telephone number, skip to step 7.

7 Press .

8 Edit the group number.

- If you do not need to edit the group number, skip to step 9.

9 Press .

10 Press (Off) to exit the program.

Intercom

An intercom is available between the portable handsets or between the main unit and portable handset(s).

Using the main unit:

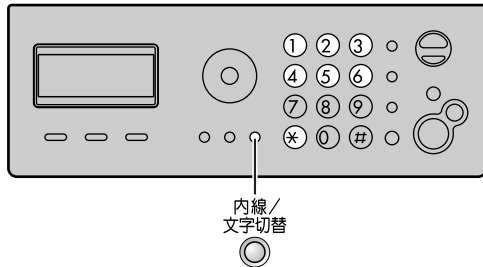

1 ■ For single portable handset users

- ① Lift the handset.

ハンゴウ?

- ② Press  (Intercom/Character input mode).

コキ1 ヨヒダシ チュウ

■ For multiple portable handset users

- ① Lift the handset.
- ② Press  (Intercom/Character input mode).
- ③ Call the portable handset(s) in the following ways:
 - To call a specific portable handset, press the portable handset number (① to ⑥) which you want to call.
 - To call all the portable handsets, press *.

2 Start talking.

Example : コキ1 ナイセンツウワ チュウ

3 Replace the handset to end the intercom call.

Using the portable handset (KX-FKN521):

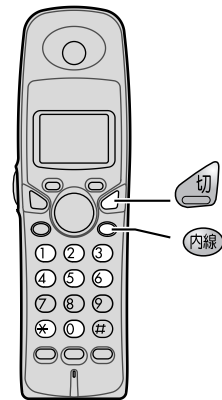

1 ■ For single portable handset users

- Press  (Intercom).

■ For multiple portable handset users

- ① Press  (Intercom).
- ② Call the main unit and/or portable handset(s) in the following ways:
 - To call a specific portable handset, press the portable handset number (① to ⑥) which you want to call.
 - To call the main unit, press ①.
 - To call the main unit and all the portable handsets, press *.

2 Start talking.



ナイセンツウワ チュウ

3 Press (Off) to end the intercom call.

Sending faxes

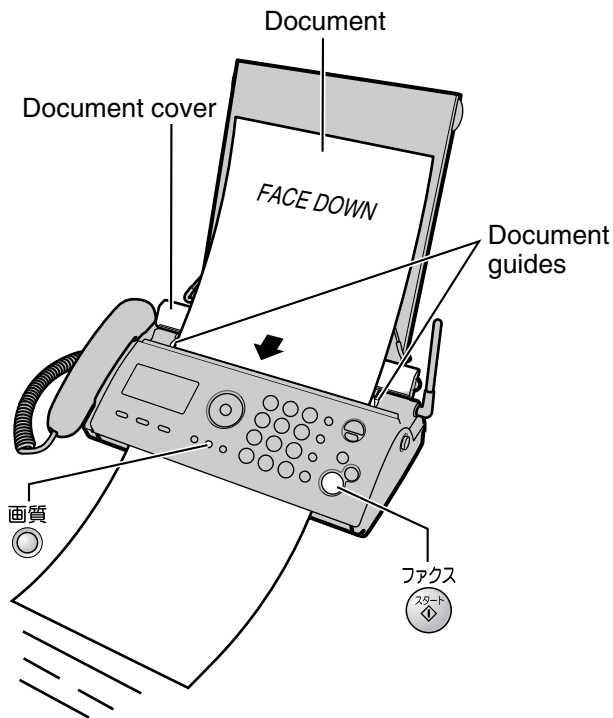
Sending a fax manually





- 1** Open the document cover, and adjust the width of the document guides to the size of the document.
- 2** Insert the document (up to 5 pages) FACE DOWN until a single beep is heard.
- 3** If necessary, press  (Resolution) repeatedly to select the desired setting (see below).
- 4** Dial the fax number.
- 5** Press  (Start/Fax).
 - The unit will start fax transmission.

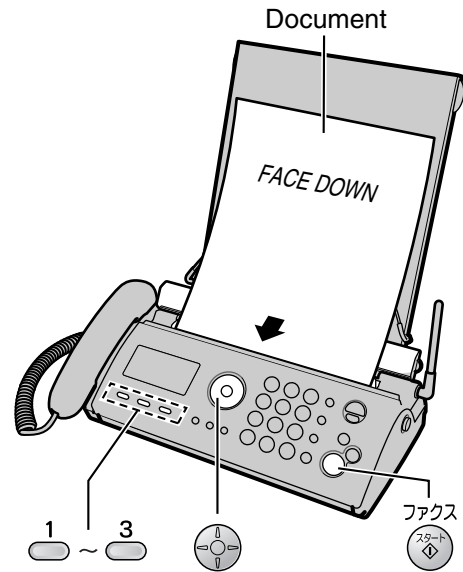

Sending a fax using automatic dialing



Using the one-touch dial

- 1** Insert the document (up to 5 pages) FACE DOWN until a single beep is heard.
- 2** Press the desired one-touch dial button ( to ).
 - The unit will start fax transmission.

Using the phonebook

- 1** Insert the document (up to 5 pages) FACE DOWN until a single beep is heard.
- 2** Press  (Phonebook).
- 3** Press  (Search button) repeatedly until the desired name is displayed.
- 4** Press  (Start/Fax).
 - The unit will start fax transmission.

To select the resolution

Select the desired resolution according to the type of document, by pressing  (Resolution).

- | | |
|-----------|---|
| カ シツ=フツウ | (Standard) for printed or typewritten originals with normal-sized characters. |
| カ シツ=チイサイ | (Fine) for originals with minute printing. |
| カ シツ=シャシヨ | (Photo) for originals containing photographs. |

Receiving faxes

Receiving a fax manually (AUTO ANSWER off)

Using the main unit:

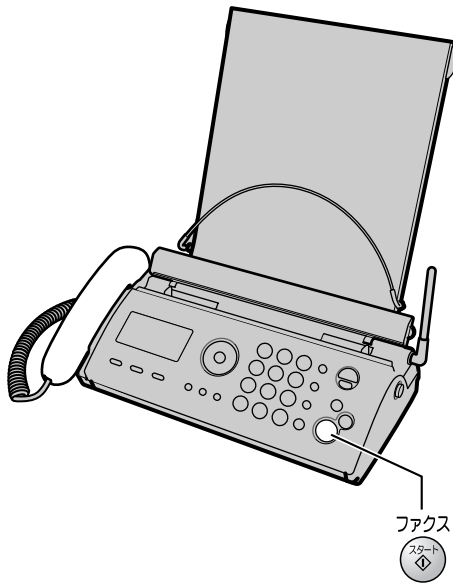

1 When you hear a ring, lift the handset to answer the call.

2 When:

- document reception is required,
- a fax calling tone (slow beep) is heard, or
- no sound is heard,

press **ファクス スタート** (Fax), then replace the handset.

- The unit will start fax reception.

Using the portable handset (KX-FKN521):

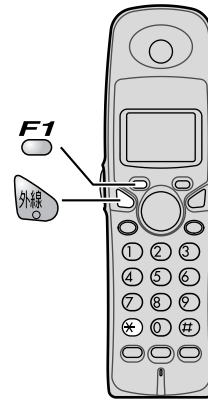

1 When you hear a ring, lift the portable handset from the charger to answer the call.

- If the portable handset is not set on the charger, press **外線** (Talk).

2 When:

- document reception is required,
- a fax calling tone (slow beep) is heard, or
- no sound is heard,

press **F1**, then press *****.

- The main unit will start fax reception.

Receiving faxes

Receiving a fax automatically (AUTO ANSWER on)

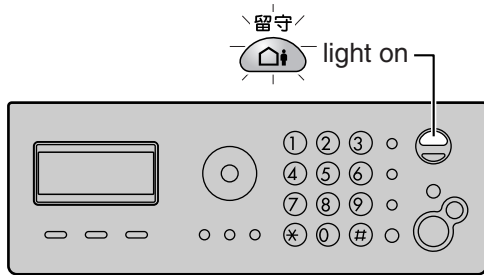

- 1 If the **留守** (Auto answer) light is off, turn it on by pressing **留守**.
- 2 When receiving a call, the unit will receive a fax document or record a voice message automatically depending on the caller's request.

Operating the built-in answering device

Recording your own greeting message

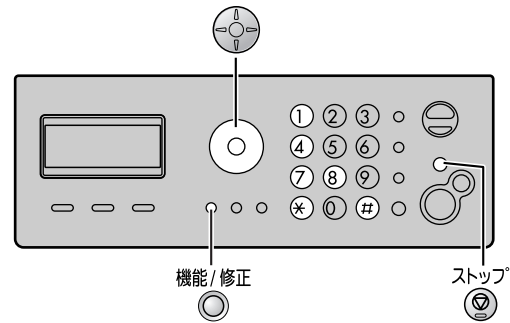

You can record your own greeting message. When receiving a call, it will be played to callers instead of the pre-recorded Japanese greeting message.

- 1 Press **機能/修正** (Function/Edit).
- 2 Press **# 1 4 7**.

ジ サク オウトウ ロクオン
[ケッテイ]オス
- 3 Press **決定** (Set).
- 4 Lift the handset.
- 5 Press **決定** (Set) and speak your greeting message after a beep, up to 16 seconds, to the handset.
- 6 Press **ストップ** (Stop) and replace the handset.
 - Your greeting message will be played back automatically.

Erasing your own greeting message

- 1 Press **機能/修正** (Function/Edit).
- 2 Press **# 1 4 8**.

ジ サク オウトウ ショウキョ
[ケッテイ]オス
- 3 Press **決定** (Set).
- 4 Press *****.
 - The pre-recorded Japanese greeting message will be played when you receive a call.

Operating the built-in answering device

Activating the answering device

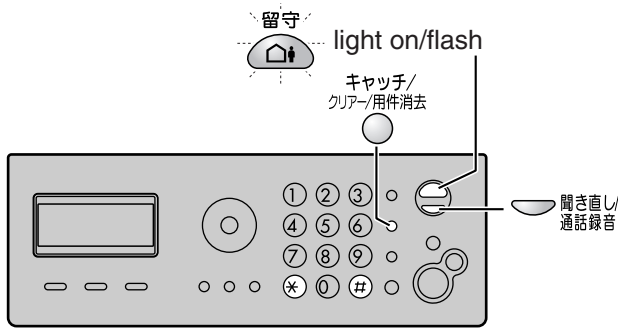

- 1 Turn the **留守** (Auto answer) light on by pressing **留守**.
- 2 When receiving a call, a greeting message will be played and the unit will record a voice message.
 - To record your own greeting message, see page 16.

Listening to recorded messages

When new messages are recorded, the **留守** (Auto answer) light will flash.

Press **留守** to listen to recorded messages.

After the messages are played back, the following will be displayed.

- To erase the messages, press *****. サイセイシタヨウケンシヨウキヨ
スル=* シナイ=#
- To save the messages, press **#**.

Listening to all of the recorded messages

Press **聞き直し/通話録音** (Replay/Record).

After the messages are played back, the following will be displayed.

- To erase the messages, press *****. サイセイシタヨウケンシヨウキヨ
スル=* シナイ=#
- To save the messages, press **#**.

Erasing a specific message

Press **キャッチ/クリア/用件消去** (Flash/Clear/Eraser) while listening to the message you want to erase, then press *****.

Erasing all of the recorded messages

- 1 Press **キャッチ/クリア/用件消去** (Flash/Clear/Eraser). スハ*テ シヨウキヨシマスカ?
ハイ=* イイエ=#
- 2 Press *****.

Operating the answering device from a remote location

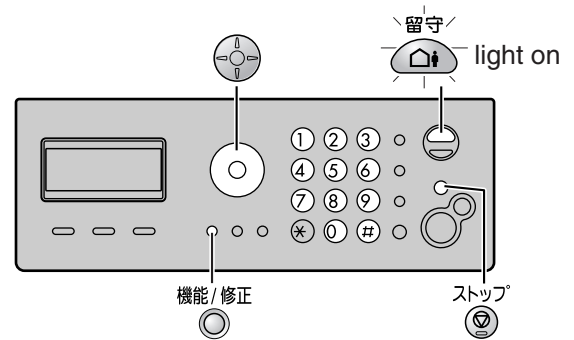

Preparation: Programming the remote operation ID

1. Press **機能/修正** (Function/Edit).
2. Press **# 0 0 6**.
3. Enter any 4-digit number (remote operation ID) except * or #.

Example : アンショウ No.=1234
[4ケタ,ケツテイ]オス

4. Press **決定** (Set).
5. Press **ストップ** (Stop).

Operation: Listening to a recorded message from a remote location

Turn the **留守** (Auto answer) light on before you go out. Remote operations are available only from a touch tone telephone.

1. Call your unit.
2. Enter the remote operation ID during the greeting message.
3. Press **2** or wait 4 seconds.
 - Only the new recorded messages will be played back.
 - To listen to all the recorded messages, press **4** after the new messages have been played back.

Specifications

KX-PW503DL KX-PW503DW	Main unit	Portable handset (KX-FKN521)	Battery charger
Power supply	AC 100 V (50 Hz/60 Hz)	Ni-MH battery (Part no. KX-FAN50) DC 3.6 V, 600 mAh	AC adaptor (Part no. PFAP1009) AC 100 V (50 Hz/60 Hz) DC 7.5 V, 100 mA
Power consumption	Transmission: Approx. 10 W Reception: Approx. 15 W Copy: Approx. 20 W Stand by: Approx. 0.9 W (When the F-net service is not in use.) Maximum(*1): Approx. 130 W		<ul style="list-style-type: none"> • Charging: Approx. 1.5 W • Stand by: Approx. 0.6 W
Dimensions (H x W x D)	Approx. 110.5 X 332.5 X 205 mm (without projections) Approx. 355.5 X 332.5 X 243 mm (recording paper cover/tray installed, without projections)	Approx. 161 X 47 X 39 mm	Approx. 64 X 80 X 90 mm
Mass (Weight)	Approx. 2.9 kg (10 m ink film installed)	Approx. 140 g (battery installed)	Approx. 80 g
Operating environment	5 °C – 35 °C, 45 % – 85 % RH (Relative Humidity)		

KX-PW503DL KX-PW503DW	Main unit
Applicable line	Public Switch Telephone Network (Tone/Pulse), F-Net, NCC Lines
DC resistance	320 Ω (*2)
Compatibility	G3 compatible
Document size	A4–A5 (Max. 216 mm in width, Max. 600 mm in length)
Effective scanning size	208 mm (A4)
Effective printing size	202 mm (A4 size plain paper)
Transmission time	Approx. 15 s/page (Original mode) (*3)
Modem speed	9,600 / 7,200 / 4,800 / 2,400 bps; Automatic fallback
Halftone level	64-level
Scanning density	Horizontal: 8 pels/mm Vertical : 7.7 lines/mm (Fine/Photo), 3.85 lines/mm (Standard)
Scanner type	Contact image sensor
Printer type	Thermal transfer printing on plain paper
Data compression system	Modified Huffman (MH), Original mode
Recording paper size	A4: 210 mm x 297 mm (Plain paper)
Answering device	Greeting message: Digital recording system (up to 16 sec) Pre-recording greeting message ICM Recording: Digital recording system (Approx. 18 min. in total) (*4)
Memory capacity	Max. Approx. 46 pages (Only receiving fax etc.) (*5) Max. Approx. 18 min. (Only Recording message) (*4)

*1 When copying a 100% black document.

*2 If you cannot make a call due to DC resistance, consult your dealer.

*3 Transmission speed is based on an A4-size document of 700 characters sent in standard resolution at 9,600 bps. The actual transmission speed depends upon the contents of the page, resolution, telephone line conditions and capability of the other party's machine.

*4 If there is a silent pause, the total recording time will be longer.

*5 The memory capacity is based on an A4-size document of 700 characters.

